

Display CARFAX in online listings:



This report provided free of charge by:

Solutionpro Auto

1395 Cobb Pkwy N Ste F-3
 Marietta, GA 30062
 (770) 933-8195



Vehicle History Report™

US \$44.99

**2015 MERCEDES-BENZ
 GLK 350**

VIN: WDCGG5HB2FG370163
 4 DOOR WAGON/SPORT
 UTILITY
 3.5L V6 F DOHC 24V
 GASOLINE
 REAR WHEEL DRIVE

This CARFAX Report Provided
 by:
Solutionpro Auto

Accident reported: minor damage

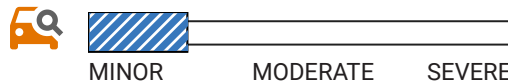

11 Service history records

2 Previous owners

Types of owners: Corporate fleet, Personal

101,254 Last reported odometer reading



This CARFAX Vehicle History Report is based only on information supplied to CARFAX and available as of 1/17/24 at 2:16:54 PM (CST). Other information about this vehicle, including problems, may not have been reported to CARFAX. Use this report as one important tool, along with a vehicle inspection and test drive, to make a better decision about your next used car.







Ownership History

The number of owners is estimated

	Owner 1	Owner 2
Year purchased	2014	2015
Type of owner	Corporate fleet	Personal
Estimated length of ownership	7 months	8 years
Owned in the following states/provinces	Alabama	Georgia
Estimated miles driven per year	---	10,896/yr
Last reported odometer reading	12,160	101,254

 Title History CARFAX guarantees the information in this section	Owner 1	Owner 2
Damage Brands Salvage Junk Rebuilt Fire Flood Hail Lemon	<input checked="" type="checkbox"/> Guaranteed No Problem	<input checked="" type="checkbox"/> Guaranteed No Problem
Odometer Brands Not Actual Mileage Exceeds Mechanical Limits	<input checked="" type="checkbox"/> Guaranteed No Problem	<input checked="" type="checkbox"/> Guaranteed No Problem
 GUARANTEED - None of these title problems were reported by a U.S. state Department of Motor Vehicles (DMV). If you find that any of these title problems were reported by a DMV and not included in this report, you may qualify. View Terms View Certificate		

 Additional History Not all accidents / issues are reported to CARFAX	Owner 1	Owner 2
Total Loss No total loss reported to CARFAX.	<input checked="" type="checkbox"/> No Issues Reported	<input checked="" type="checkbox"/> No Issues Reported
Structural Damage CARFAX recommends that you have this vehicle inspected by a collision repair specialist.	<input checked="" type="checkbox"/> No Issues Reported	<input checked="" type="checkbox"/> No Issues Reported
Airbag Deployment No airbag deployment reported to CARFAX.	<input checked="" type="checkbox"/> No Issues Reported	<input checked="" type="checkbox"/> No Issues Reported
Odometer Check No indication of an odometer rollback.	<input checked="" type="checkbox"/> No Issues Indicated	<input checked="" type="checkbox"/> No Issues Indicated
Accident / Damage Damage reported: 12/31/2014 and 01/03/2023. Accidents reported: 02/04/2017, 10/30/2018, and 03/19/2020.	Minor Damage	Minor Damage
Manufacturer Recall Check with an authorized Mercedes-Benz dealer for any open recalls.	<input checked="" type="checkbox"/> No Recalls Reported	<input checked="" type="checkbox"/> No Recalls Reported
Basic Warranty Original warranty estimated to have expired.	Warranty Expired	Warranty Expired

 Detailed History			
 Owner 1 Purchased: 2014		Corporate Fleet Vehicle	
Date	Mileage	Source	Comments
10/06/2014	12	Mercedes-Benz of Tuscaloosa Tuscaloosa, AL	 Vehicle serviced - Pre-delivery inspection completed

205-556-1111
mercedesoftuscaloosa.com

★ 4.9 / 5.0

39 Verified Reviews

♥ 631 Customer Favorites

10/31/2014 15

Alabama
Motor Vehicle Dept.

Vehicle purchase reported

- Registration issued or renewed
- Titled or registered as corporate fleet vehicle
- Vehicle color noted as White

11/20/2014

Alabama
Motor Vehicle Dept.
Gordo, AL
Title #49631456

Title issued or updated

- First owner reported
- Loan or lien reported
- Vehicle color noted as White

12/31/2014

Damage Report



Damage reported: minor damage

- Damage to front



CARFAX HAS THE MOST ACCIDENT & DAMAGE INFORMATION

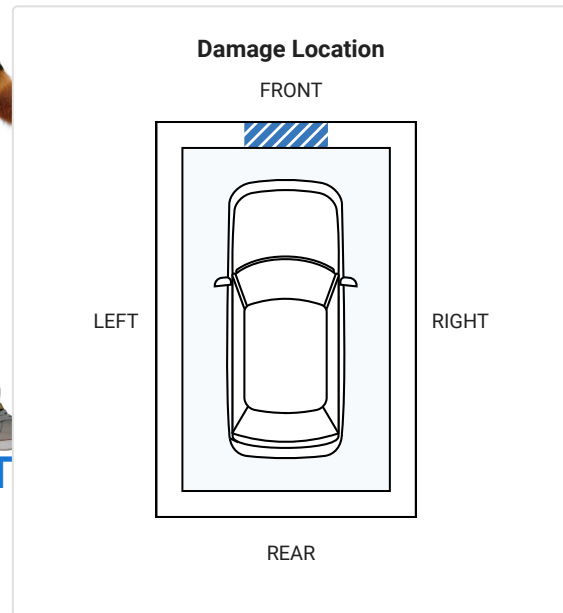
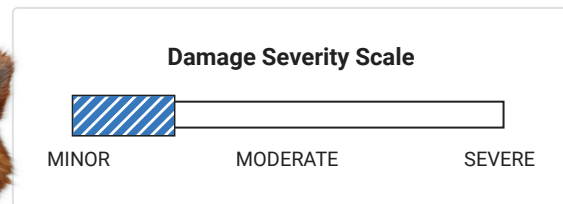

Minor damage is usually cosmetic, including dents or scratches to the vehicle body.

03/20/2015

Alabama
Motor Vehicle Dept.
Gordo, AL

Registration issued or renewed

- Vehicle color noted as White

06/24/2015 12,160 Mercedes-Benz Financial Services Georgia

Vehicle sold at auction



Millions of used vehicles are bought and sold at auction every year.

06/26/2015 Dealer Inventory

Vehicle offered for sale

Owner 2
Purchased: 2015



Low mileage! This owner drove less than the industry average of 15,000 miles per year.

Personal Vehicle
10,896 mi/yr

Date	Mileage	Source	Comments
11/07/2015		Georgia Motor Vehicle Dept.	Vehicle purchase reported
12/01/2015	14,734	Georgia Motor Vehicle Dept. Atlanta, GA Title #770314153354001	Vehicle purchase reported - Title issued or updated - Registration issued or renewed - New owner reported - Vehicle color noted as White
11/11/2016		Georgia Motor Vehicle Dept. Atlanta, GA Title #770314153354001	Registration issued or renewed - Vehicle color noted as White

02/04/2017 Damage Report



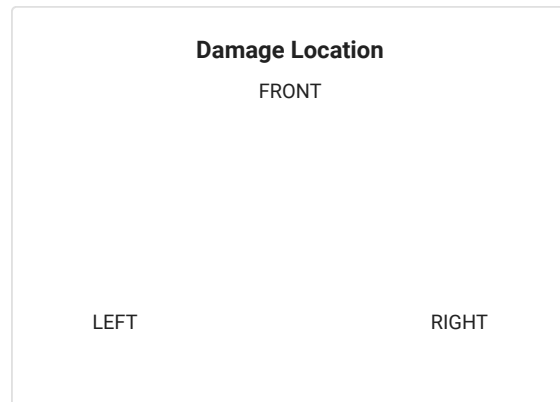
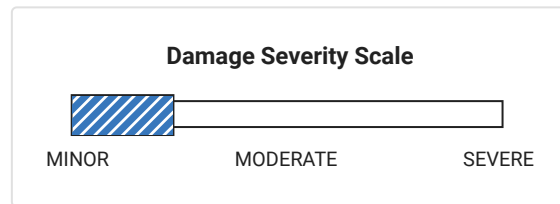

Accident reported: minor damage
- Damage to right front
- Damage to front
- Airbags did not deploy

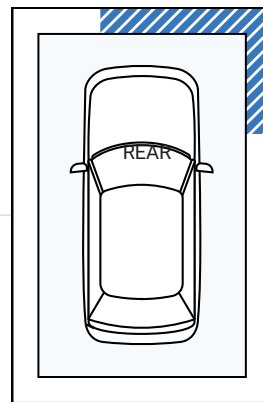



CARFAX HAS THE MOST ACCIDENT & DAMAGE INFORMATION

12/04/2017	Georgia Motor Vehicle Dept. Atlanta, GA Title #770314153354001	Registration issued or renewed - Vehicle color noted as White
07/17/2018 54,892	Pep Boys Atlanta, GA 404-963-8038 pepboys.com ★ 3.7 / 5.0 64 Verified Reviews ♥ 82 Customer Favorites	 Vehicle serviced - Maintenance inspection completed - Tire(s) balanced - Tire repaired
10/30/2018	Damage Report	 Accident reported: minor damage - Damage to left side - Damage to left rear - Damage to front - Airbags did not deploy

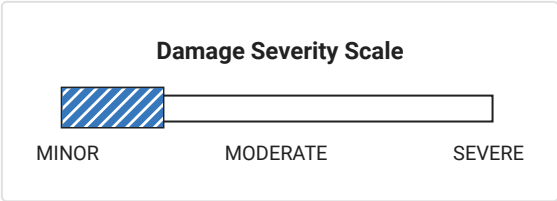

Damage Location

FRONT

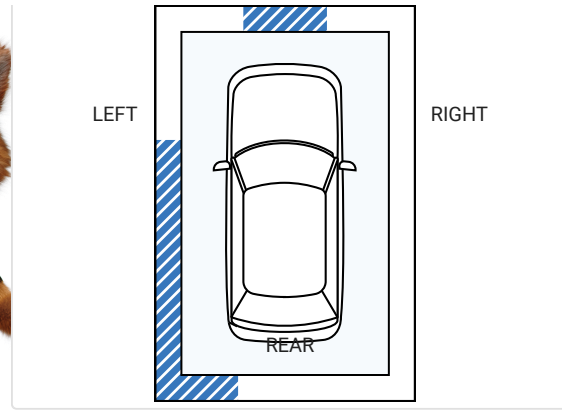

CARFAX HAS THE MOST ACCIDENT & DAMAGE INFORMATION

12/07/2018	58,023	Georgia Inspection Station		Passed emissions inspection
12/07/2018		Georgia Motor Vehicle Dept. Atlanta, GA Title #770314153354001		Registration issued or renewed - Vehicle color noted as White
05/16/2019	62,586	Revolution Benz Decatur, GA 404-292-2683 revolutionbenz.com ★ 4.9 / 5.0 90 Verified Reviews ♥ 45 Customer Favorites		Vehicle serviced - Wiper(s) replaced - Brake pads replaced - Alignment performed - Two tires mounted - Two tires balanced - Front brake pads replaced - Alignment checked - Antifreeze/coolant checked - Tire condition and pressure checked
12/07/2019	70,009	Georgia Inspection Station		Passed emissions inspection
12/07/2019		Georgia Motor Vehicle Dept. Atlanta, GA Title #770314153354001		Registration issued or renewed - Vehicle color noted as White
12/20/2019	70,316	Revolution Benz Decatur, GA 404-292-2683 revolutionbenz.com		Vehicle serviced

★ 4.9 / 5.0

90 Verified Reviews

♥ 45 Customer Favorites

01/10/2020 71,654

Revolution Benz
Decatur, GA
404-292-2683
revolutionbenz.com



Vehicle serviced

- Battery replaced
- Battery/charging system checked
- Oil and filter changed
- Fluids checked

★ 4.9 / 5.0

90 Verified Reviews

♥ 45 Customer Favorites

03/19/2020

Damage Report



Accident reported: minor damage

- Vehicle involved in a sideswipe collision
- Damage to left rear
- Damage to rear
- Airbags did not deploy



CARFAX HAS THE MOST ACCIDENT & DAMAGE INFORMATION

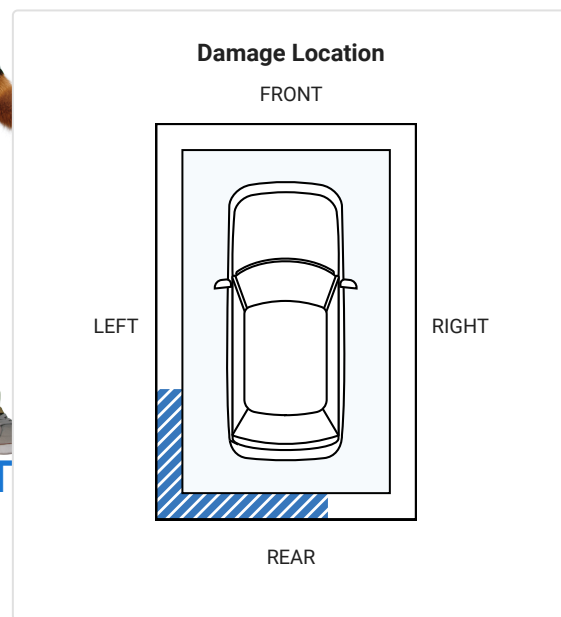
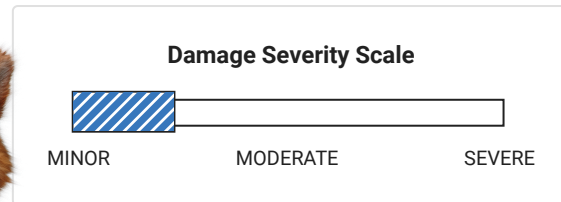

12/15/2020 78,122

Revolution Benz
Decatur, GA
404-292-2683
revolutionbenz.com



Vehicle serviced

- Wiper(s) replaced
- Oil and filter changed
- Rear brake pads replaced
- Fluids checked
- Engine mount(s) replaced

★ 4.9 / 5.0





90 Verified Reviews

♥ 45 Customer Favorites

12/16/2020 78,124

Georgia

Passed emissions inspection

Inspection Station		
12/16/2020		<p>Georgia Motor Vehicle Dept. Atlanta, GA Title #770314153354001</p> <p>Registration issued or renewed - Vehicle color noted as White</p>
11/13/2021	83,534	<p>Georgia Inspection Station</p> <p>Passed emissions inspection</p>
11/14/2021		<p>Georgia Motor Vehicle Dept. Atlanta, GA Title #770314153354001</p> <p>Registration issued or renewed - Vehicle color noted as White</p>
12/10/2021	83,776	<p>Revolution Benz Decatur, GA 404-292-2683 revolutionbenz.com</p> <p>★ 4.9 / 5.0 90 Verified Reviews ❤️ 45 Customer Favorites</p> <p> Vehicle serviced - Wiper(s) replaced - Oil and filter changed - Fluids checked - Differential fluid flushed/changed</p>
06/28/2022	89,095	<p>Revolution Benz Decatur, GA 404-292-2683 revolutionbenz.com</p> <p>★ 4.9 / 5.0 90 Verified Reviews ❤️ 45 Customer Favorites</p> <p> Vehicle serviced - Windshield replaced - Windshield repaired</p>
11/26/2022	91,096	<p>Georgia Inspection Station</p> <p>Passed emissions inspection</p>
11/26/2022		<p>Georgia Motor Vehicle Dept. Atlanta, GA Title #770314153354001</p> <p>Registration issued or renewed - Vehicle color noted as White</p>
12/09/2022	91,286	<p>Revolution Benz Decatur, GA 404-292-2683 revolutionbenz.com</p> <p>★ 4.9 / 5.0 90 Verified Reviews ❤️ 45 Customer Favorites</p> <p> Vehicle serviced - Oil and filter changed - Fluids checked - Transmission fluid changed - Front brake pads replaced - Brake pads replaced - Front brake rotor(s) replaced - Spark plug(s) replaced - Brake fluid flushed/changed - Air filter replaced - Tire condition and pressure checked - Two tires replaced</p>
01/03/2023		<p>Damage Report</p> <p> Damage reported: minor damage</p>

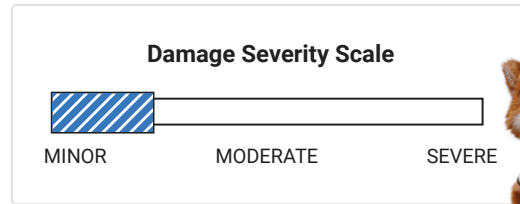

01/09/2023	92,566	Revolution Benz Decatur, GA 404-292-2683 revolutionbenz.com		Vehicle serviced - Antifreeze/coolant checked - Tire condition and pressure checked - Brakes checked
		★ 4.9 / 5.0 90 Verified Reviews ❤️ 45 Customer Favorites		
11/07/2023	101,252	Curry Honda Atlanta, GA 678-430-7847 curryhondaga.com/? utm_source=gmb_listing &utm_medium=organic	Vehicle offered for sale	
		★ 4.3 / 5.0 279 Verified Reviews ❤️ 22 Customer Favorites		
11/15/2023	101,254	Curry Honda Chamblee, GA 678-430-7847 curryhondaga.com/		Vehicle serviced - Oil and filter changed - Tire(s) balanced - Tires rotated - Vehicle washed/detailed
		★ 4.3 / 5.0 279 Verified Reviews ❤️ 22 Customer Favorites		
			Looks like this dealer serviced the car in order to prepare it for sale. That's a good thing!	
11/18/2023		Georgia Inspection Station	Failed emissions inspection	
11/20/2023		Georgia Inspection Station	Passed emissions inspection	

Have Questions? Consumers, please visit our Help Center at www.carfax.com. Dealers or Subscribers, please visit our Help Center at www.carfaxonline.com.



Glossary

Accident Indicator

CARFAX receives information about accidents in all 50 states, the District of Columbia and Canada.

Not every accident is reported to CARFAX. As details about the accident become available, those additional details are added to the CARFAX Vehicle History Report. CARFAX recommends that you have this vehicle inspected by a qualified mechanic.

- According to the National Safety Council, Injury Facts, 2021 edition, 5% of the 276 million registered vehicles in the U.S. were involved in an accident in 2019. Over 77% of these were considered minor or moderate.
- This CARFAX Vehicle History Report is based only on information supplied to CARFAX and available as of 1/17/24 at 2:16:54 PM (CST). Other information about this vehicle, including problems, may not have been reported to CARFAX. Use this report as one important tool, along with a vehicle inspection and test drive, to make a better decision about your next used car.

Damage Indicator

Damage can be a result of many different types of events. Examples include contact with objects (other cars, trees, traffic signs, road debris, etc), vandalism, or weather-related events. Not every damage event is reported to CARFAX. As details about the damage event become available, those additional details are added to the CARFAX Vehicle History Report. CARFAX recommends that you have this vehicle inspected by a qualified mechanic.

- This CARFAX Vehicle History Report is based only on information supplied to CARFAX and available as of 1/17/24 at 2:16:54 PM (CST). Other information about this vehicle, including problems, may not have been reported to CARFAX. Use this report as one important tool, along with a vehicle inspection and test drive, to make a better decision about your next used car.

Damage Severity

Damage events result in one of the following severity levels:

- Minor: Generally, minor damage is cosmetic (including dents or scratches), may only require reconditioning, and typically does not compromise a vehicle's operation and/or safety.
- Moderate: Moderate damage may affect multiple components of the vehicle and may impair the vehicle's operation and/or safety.
- Severe: Severe damage usually affects multiple components of the vehicle and is likely to compromise the vehicle's operation and/or safety.

CARFAX recommends getting a pre-purchase inspection at a certified collision repair facility.

Failed Emissions Inspection

The emissions check performed during a vehicle inspection indicated the vehicle was emitting more than allowable emissions standards and/or had missing or modified parts. Repeated failed emissions records can indicate engine problems and CARFAX recommends you have the vehicle inspected.

First Owner

When the first owner(s) obtains a title from a Department of Motor Vehicles as proof of ownership.

Fleet Vehicle

Vehicle was registered or sold to a company that manages vehicle fleets.

New Owner Reported

When a vehicle is sold to a new owner, the Title must be transferred to the new owner(s) at a Department of Motor Vehicles.

Ownership History

CARFAX defines an owner as an individual or business that possesses and uses a vehicle. Not all title transactions represent changes in ownership. To provide estimated number of owners, CARFAX proprietary technology analyzes all the events in a vehicle history. Estimated ownership is available for vehicles manufactured after 1991 and titled solely in the US including Puerto Rico. Dealers sometimes opt to take ownership of a vehicle and are required to in the following states: Maine, Massachusetts, New Jersey, Ohio, Oklahoma, Pennsylvania and South Dakota. Please consider this as you review a vehicle's estimated ownership history.

Title Issued

A state issues a title to provide a vehicle owner with proof of ownership. Each title has a unique number. Each title or registration record on a CARFAX report does not necessarily indicate a change in ownership. In Canada, a registration and bill of sale are used as proof of ownership.

Follow Us:  facebook.com/CARFAX  @CARFAXinc  About CARFAX

CARFAX DEPENDS ON ITS SOURCES FOR THE ACCURACY AND RELIABILITY OF ITS INFORMATION. THEREFORE, NO RESPONSIBILITY IS ASSUMED BY CARFAX OR ITS AGENTS FOR ERRORS OR OMISSIONS IN THIS REPORT. CARFAX FURTHER EXPRESSLY DISCLAIMS ALL WARRANTIES, EXPRESS OR IMPLIED, INCLUDING ANY IMPLIED WARRANTIES OF MERCHANTABILITY OR FITNESS FOR A PARTICULAR PURPOSE.

© 2024 CARFAX, Inc., part of S&P Global. All rights reserved.
1/17/24 2:16:54 PM (CST)

I have reviewed and received a copy of the CARFAX Vehicle History Report for this 2015 MERCEDES-BENZ GLK vehicle (VIN: WDCGG5HB2FG370163), which is based on information supplied to CARFAX and available as of 1/17/24 at 3:16 PM (EST).

Customer Signature

Date

Dealer Signature

Date